

MAC Axiom™ Hybrid

User manual

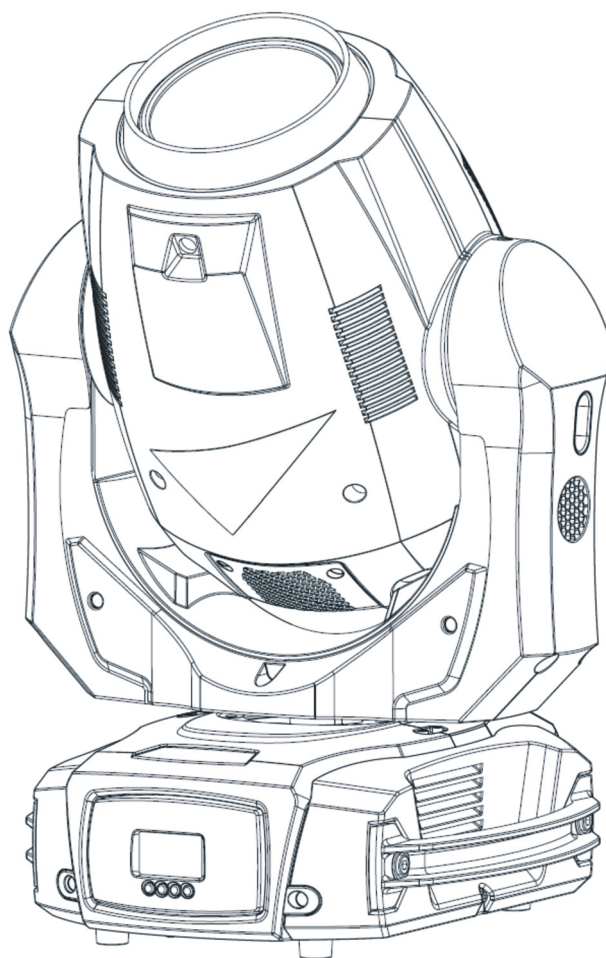

Martin[®]
by HARMAN

Information subject to change without notice. HARMAN Professional Denmark ApS disclaims liability for any injury, damage, direct or indirect loss, consequential or economic loss or any other loss occasioned by the use of, inability to use or reliance on the information contained in this document.

©2013-2018 HARMAN Professional Denmark ApS. All rights reserved. Martin® is a registered trademark of HARMAN Professional Denmark ApS registered in the United States and/or other countries. Features, specifications, and appearance are subject to change without notice.

HARMAN Professional Denmark ApS – Olof Palmes Alle 18 – 8200 Aarhus N – Denmark
www.martin.com

MAC Axiom Hybrid User Manual Revision E

Table of contents

Safety information	4
Protection from electric shock	5
Protection from burns and fire	5
Lamp safety	6
Protection from eye injury.....	6
Protection from injury	6
Introduction	8
Before using the product for the first time	8
Tilt lock	8
Physical installation	9
Fastening the fixture to a flat surface	9
Mounting the fixture on a truss	9
Securing with a safety cable.....	10
AC power	11
Fixture overview	12
DMX data link	12
Connecting the data link.....	13
Fixture setup.....	14
Using the control panel.....	14
DMX address.....	14
Personality.....	14
Factory default.....	15
Information	15
DMX Live	16
Test.....	16
Manual control	16
Effects	17
Dimming	17
Strobe effects	17
Cyan, Magenta, Yellow and CTO.....	17
Rotating gobos	17
Fixed gobos	18
Color wheel	19
Prisms and prism lineator.....	20
Frost	20
Focus/Zoom linking	20
Pan and tilt	20
Service and maintenance	21
Cleaning	21
Access inside the head	22
Lamp replacement.....	23
Replacing the prism.....	25
Replacing a rotating gobo	27
Handling gobos	29
Replacing the primary fuse.....	29
DMX protocol	30
Control menus.....	35
Error messages.....	38
Troubleshooting	39
Specifications	40

Safety information



WARNING!

Read the safety precautions in this manual before installing, operating or servicing this product.

The following symbols are used to identify important safety information on the product and in this manual:



Warning! Safety hazard.
Risk of severe injury or death.



Warning! Hot surface. Risk of burns.



Warning! See user manual for important safety information.



Warning! Risk of eye injury. Wear protective eyewear.



Warning! Hazardous voltage. Risk of lethal or severe electric shock.



Warning! Do not look into light output.



Warning! Fire hazard.



Warning! Wear protective gloves.



Warning! Risk Group 2 product according to EN 62471. Avoid looking directly into the beam and do not view the light output with optical instruments or any device that may concentrate the beam.



This lighting fixture is for professional use only – it is not for household use. The fixture must be installed by a qualified technician. The safety of the installation is the responsibility of the installer. The fixture presents risks of severe injury or death due to fire hazards, electric shock and falls. It produces a powerful, concentrated beam of light that can create a fire hazard or a risk of eye injury if the safety precautions below are not followed.

If you have any questions about how to install, operate or service the fixture safely, please contact your Martin® distributor (see www.martin.com/distributors for details) or call the Martin® 24-hour service hotline on +45 8740 0000, or in the USA on 1-888-tech-180.

Respect all locally applicable laws, codes and regulations when installing, operating or servicing the fixture.

Refer any service operation not described in this manual to an authorized Martin® service technician. Do not try to carry out any such operation yourself, as doing so may present a health or safety risk. It may also cause damage or malfunction and it may void your product warranty.



Before you use this product, please visit the Martin® website at <http://www.martin.com> and make sure that you have all the latest user documentation for this product and for any other Martin® products that you intend to use.

Install, operate and service Martin® products only as directed in their user manuals, or you may create a safety hazard or cause damage that is not covered by product warranties.

Follow the safety precautions listed below and observe all warnings in this manual and printed on the product. Keep this manual for future use.



Protection from electric shock

Do not expose the fixture to rain or moisture.

Disconnect the fixture from AC power before carrying out any installation or maintenance work, such as changing the lamp, and when the fixture is not in use.

Ensure that the fixture is electrically connected to ground (earth).

Use only a source of AC power that complies with local building and electrical codes and has both overload and ground-fault (earth-fault) protection.

Socket outlets or external power switches used to supply the fixture with power must be located near the fixture and easily accessible so that the fixture can easily be disconnected from power.

The power input cable must be rated 10 A, hard usage type, heat-resistant to 90° C (194° F) minimum and temperature-rated to suit the application. It must have three conductors and an outer cable diameter of 5 - 15 mm (0.2 - 0.6 in.). In the USA and Canada the cable must be UL listed, type SJT or equivalent. In the EU the cable must be type H05VV-F or equivalent.

Use only a Neutrik PowerCon TRUE1 cable connector to connect to the fixture's power socket.

Before using the fixture, check that all power distribution equipment and cables are in perfect condition and rated for the current requirements of all connected devices.

Isolate the fixture from power immediately if the power plug or any seal, cover, cable, or other component is damaged, defective, deformed, wet or showing signs of overheating. Do not reapply power until repairs have been completed.

Replace defective fuses with ones of the specified type and rating only.



Protection from burns and fire

Do not use the fixture to illuminate surfaces within 15 m (49.2 ft.) of the fixture.

Do not operate the fixture if the ambient temperature (T_a) exceeds 40° C (104° F).

The surface of the product casing can reach up to 90° C (194° F) during operation.

Avoid contact by persons and materials. Allow the fixture to cool for at least 20 minutes before handling.

Keep flammable materials well away from the fixture. Keep all combustible materials (e.g. fabric, wood, paper) at least 100 mm (4 in.) away from the fixture head.

Ensure that there is free and unobstructed airflow around the fixture. Provide a minimum clearance of 100 mm (4 in.) around fans and air vents.

Do not attempt to bypass thermostatic switches or fuses.

Do not stick filters, masks or other materials onto any optical component.





Lamp safety

Install only a lamp that is approved for use in the product.



Prolonged exposure to an unshielded discharge lamp can cause eye and skin burns. Do not look directly into the light output.

Never look at an exposed lamp while it is lit.

Do not operate the fixture with missing or damaged covers, shields, lenses, ultraviolet screens or any optical component.

A hot discharge lamp is under pressure and can explode without warning. Allow the fixture to cool for at least 60 minutes and protect yourself with safety glasses and gloves before handling a lamp.

Replace the lamp immediately if it becomes visually deformed, damaged or in any way defective. Replace the lamp if light output intensity falls noticeably.

Monitor hours of lamp use and replace the lamp before it reaches the limit of its service life as specified in this manual or by the lamp manufacturer.

If the quartz envelope of a discharge lamp is broken, the lamp releases a small quantity of mercury and other toxic gases. If a discharge lamp explodes in a confined area, evacuate the area and ventilate it thoroughly. Wear nitrile gloves when handling a broken discharge lamp. Treat broken or used discharge lamps as hazardous waste and send to a specialist for disposal.



Protection from eye injury

The fixture emits infrared and ultraviolet rays that are not normally visible but that may be harmful to the eyes and skin. Do not stare at an operating lamp. Minimize exposure to eyes or skin. Use appropriate shielding or eye protection.

Do not look directly into the light beam. Do not point the beam in a direction where a person can look directly into it.

Ensure that persons are not looking at the light beam when the product lights up suddenly. This can happen when power is applied, when the product receives a DMX signal, or when certain control menu items are selected.

Do not look at the light output with magnifiers, telescopes, binoculars or similar optical instruments that may concentrate the light output.

To minimize the risk of eye irritation or injury, disconnect the fixture from power at all times when the fixture is not in use, and provide well-lit conditions to reduce the pupil diameter of anyone working on or near the fixture.

Do not operate the fixture with missing or damaged covers, shields or any optical component. If shields, lenses or ultraviolet screens have become visibly damaged to such an extent that their effectiveness is impaired, for example by cracks or deep scratches, return the fixture to an authorized Martin® service agent for replacement.



Protection from injury

Fasten the fixture securely to a fixed surface or structure when in use. The fixture is not portable when installed.

Ensure that any supporting structure and/or hardware used can hold at least 10 times the weight of all the devices they support.

If suspending from a rigging structure, fasten the fixture to a rigging clamp. Do not use safety cables as the primary means of support.

Always install as directed in this manual a secondary attachment such as a safety cable that will hold the fixture if a primary attachment fails. The secondary attachment must be approved by an official body such as TÜV as a safety attachment for the weight that it

secures, must comply with EN 60598-2-17 Section 17.6.6 and must be capable of bearing a static suspended load that is ten times the weight of the fixture and all installed accessories.

Allow enough clearance around the head to ensure that it cannot collide with an object or another fixture when it moves.

Check that all external covers and rigging hardware are securely fastened.

Block access below the work area and work from a stable platform whenever installing, servicing or moving the fixture.

Do not lift or carry the fixture by its head. Always ensure that the fixture is supported by its base.

In the event of an operating problem, stop using the fixture immediately and disconnect it from power. Never attempt to use a fixture that is obviously damaged.

Do not modify the fixture or install other than genuine Martin® parts.

Introduction

The MAC Axiom™ Hybrid is a true all-in-one product, combining beam and spot into one compact unit that also offers diffused wash functionality.

The high-precision optical system offers exceptional contrast, both in mid-air and projection, as well as a surprisingly flat field, usually not seen with this short-arc lamp technology.

The implementation of the CMY color palette from the MAC Viper gives designers the advantage of unlimited choice from subtle pastel shades to deep and saturated colors.

All this comes in a small footprint and lightweight product that delivers superior performance in the best feature vs. size and weight ratio available in the market.

Before using the product for the first time

Read 'Safety information' on page 4 before installing, powering, operating or servicing the fixture.

Unpack and ensure that there is no transportation damage before using the fixture. Never attempt to operate a damaged fixture.

Prepare a power cable as described under 'AC power' on page 11.

Ensure that the voltage and frequency of the local power source match the mains power requirements of the fixture.

Release the tilt lock before operating the fixture.

Check the MAC Axiom™ support pages on the Martin Professional website at www.martin.com for the most recent user documentation and technical information for the fixture. Martin® user manual revisions are identified by the revision letter at the bottom of the inside cover.

Note that whenever AC mains power is applied to the fixture, it will reset all effects and functions to their home positions and the fixture head will move. This process usually takes around 53 seconds.

Tilt lock

See illustration below.

- Release the tilt lock before putting the fixture into its flightcase and before operating the fixture.
- Apply the tilt lock if convenient while moving or servicing the fixture.



Physical installation



Warning! Read ‘Safety information’ on page 4 before installing the fixture.

The fixture is designed for indoor use only and must be used in a dry location with adequate ventilation. Ensure that none of the fixture’s ventilation slots are blocked.

Fasten the fixture to a secure structure or surface. Do not stand it on a surface or leave it where it can be moved or fall over. Always secure the fixture as directed in this user manual using a securely anchored safety cable that will hold the fixture if the primary fastening method fails.

Do not use the fixture to illuminate surfaces within 15 m (50 ft.) of the fixture.

Martin® can supply rigging hardware that is suitable for use with the fixture (see ‘Accessories’ on page 47).

Fastening the fixture to a flat surface

The fixture can be fastened to a hard, fixed, flat surface that is oriented at any angle. Ensure that the surface and all fasteners used can support at least 10 times the weight of all fixtures and equipment they will support.

Fasten the fixture securely. Always install a safety cable as directed in ‘Securing with a safety cable’ below.

Mounting the fixture on a truss

The fixture can be clamped to a truss or similar rigging structure in any orientation. When installing the fixture hanging vertically down, you can use an open-type clamp such as a G-clamp. When installing in any other orientation, you must use a closed-type rigging clamp such as half-coupler clamp (see illustration on right) that completely encircles the truss chord.



To clamp the fixture to a truss:

1. Check that the rigging structure can support at least 10 times the weight of all fixtures and equipment to be installed on it.
2. Block access under the work area.
3. The fixture is supplied with two omega-type brackets to which rigging clamps can be attached. Check that the rigging clamps are undamaged and approved for the fixture’s weight. Bolt a rigging clamp securely to each bracket. The bolts used must be M12, grade 8.8 steel minimum, and fastened with self-locking nuts.
4. Fasten the omega brackets to the base of the fixture using the brackets’ quarter-turn fasteners. Turn quarter-turn fasteners a full 90° to lock them (see illustration on right).
5. Working from a stable platform, hang the fixture on the truss and fasten the rigging clamps onto the truss.
6. Secure the fixture with a safety cable as directed below.
7. Check that the head will not collide with other fixtures or objects.

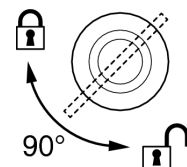

Securing with a safety cable

Secure the fixture with a safety cable (or other secondary attachment) that is approved for the weight of the fixture so that the safety cable will hold the fixture if a primary attachment fails.

Attach the safety cable to the attachment point in the fixture's baseplate (arrowed in illustration on right) and loop it around a secure anchoring point.

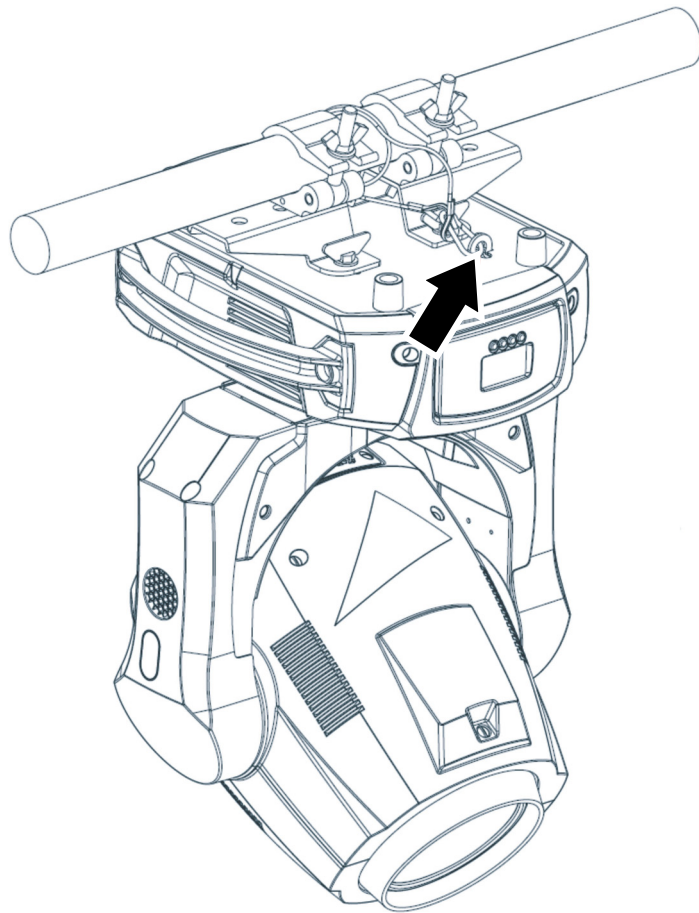

AC power



Warning! Read 'Safety information' on page 4 before connecting the fixture to AC mains power.

For protection from electric shock, the fixture must be electrically connected to ground (earth). The AC mains power distribution circuit must be equipped with a fuse or circuit breaker and ground-fault (earth-fault) protection.



Socket outlets or external power switches used to supply the fixture with power must be located near the fixture and easily accessible so that the fixtures can easily be disconnected from power.

Do not use an external dimming system to supply power to the fixture, as this may cause damage to the fixture that is not covered by the product warranty.

The MAC Axiom Hybrid requires a power input cable with a Neutrik PowerCon TRUE1 NAC3FX-W female cable connector for AC mains power input. The cable must meet the requirements listed under "Protection from electric shock" on page 5.

Martin® can supply either a suitable 3 m (9.8 ft.) power cable with PowerCon TRUE1 input connector installed or the PowerCon TRUE1 input connector without a cable (see "Accessories" on page 42).

The fixture can be hard-wired to a building electrical installation if you want to install it permanently, or a power plug (not supplied) that is suitable for the local power outlets can be installed on the power cable.

If you install a power plug on the power cable, follow the plug manufacturer's instructions and connect the wires in the power cable as shown in this table:

	Earth, Ground or ⊕	Neutral or N	Live or L
US system	Green	White	Black
EU system	Yellow/green	Blue	Brown

The fixture has an auto-ranging power supply that accepts AC mains power at 100-240 V at 50/60 Hz. Do not apply AC mains power at any other voltage or frequency to the fixture.

Fixture overview

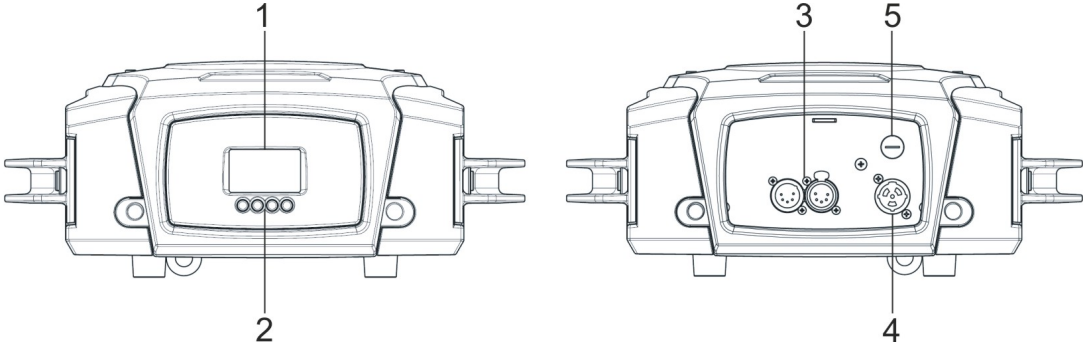

1 – Display

2 – Control buttons:

MENU	Activate the menu mode functions, or Return to the previous level of the menu structure, or Press and hold to exit the menus
ENTER	Confirm the selected menu item
DOWN	Go down a menu branch
UP	Go down a menu branch

3 - DMX XLR input/output sockets (5-pin locking XLR)

4 – AC mains power IN socket (Neutrik PowerCON TRUE1)

5 – Primary (mains power) fuse

DMX data link

A DMX 512 control data link is required in order to control the fixture via DMX. The fixture has 5-pin XLR connectors for DMX data input and output (throughput).

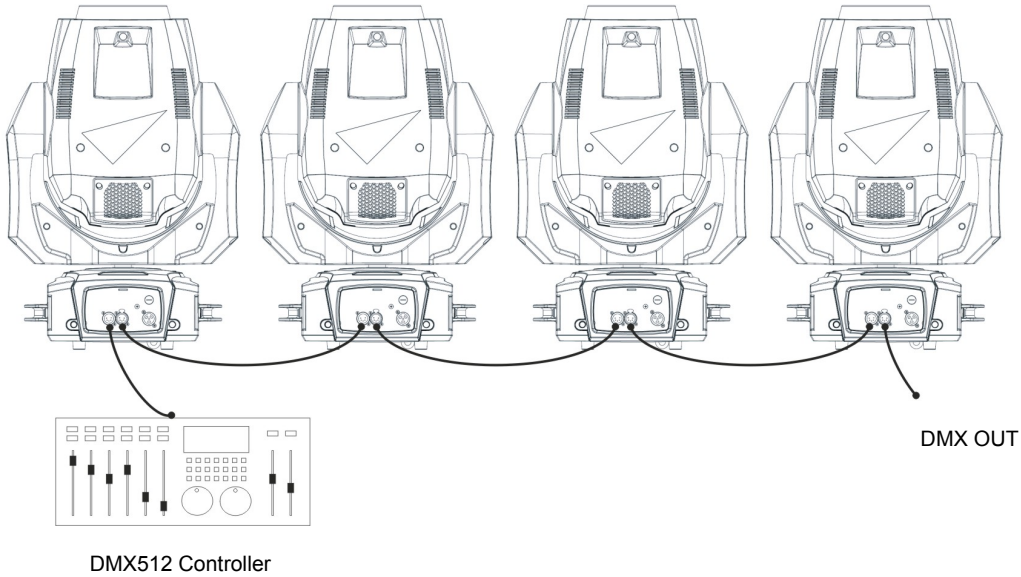

The number of daisy-chained fixtures is limited by the number of DMX channels required by the fixtures in relation to the maximum 512 channels available in one DMX universe. Note that if independent control of a fixture is required, it must have its own DMX channels. Fixtures that are required to behave identically can share the same DMX address and channels. To add more fixtures or groups of fixtures when the above limit is reached, add a DMX universe and another daisy-chained link.

Note that if a fixture loses its DMX signal it will maintain its current effect until powered off or reset.

Tips for reliable data transmission

Use shielded twisted-pair cable designed for RS-485 devices: standard microphone cable cannot transmit control data reliably over long runs. 24 AWG cable is suitable for runs up to 300 meters (1000 ft.). Heavier gauge cable and/or an amplifier is recommended for longer runs. The pin-out on 5-pin XLR connectors is:

- pin 1 = shield
- pin 2 = cold (-)
- pin 3 = hot (+)

Pins 4 and 5 are not used in the fixture but are available for possible additional data signals as required by the DMX512-A standard. Standard pin-out for these terminals is:

- pin 4 = data 2 cold (-)
- pin 5 = data 2 hot (+)

Creating branches

To split the link into branches, use a splitter such as the Martin® DMX 5.3 Splitter™ or Martin® RDM 5.5 Splitter™.

Terminating the link

Terminate the link by installing a termination plug in the output socket of the last fixture. The termination plug, which is a male XLR plug with a 120 Ohm, 0.25-Watt resistor soldered between pins 2 and 3, “soaks up” the control signal so it does not reflect and cause interference. If a splitter is used, terminate each branch of the link.

Connecting the data link

To connect the fixture to data:

1. Connect the DMX data output from the controller to the first fixture’s male XLR DMX input connector.
2. Connect the first fixture’s DMX output to the DMX input of the next fixture and continue connecting fixtures output to input.
3. Terminate the last fixture on the link with a DMX termination plug.

Fixture setup

This section explains the options available to change the fixture's settings. Settings are made using the menus available in the control panel and are retained when the fixture is powered off.

A complete map of the control menu structure and brief explanations of their purposes can be found in 'Control menus' on page 35.

Using the control panel

- To access the control menus, press the MENU button.
- Navigate the menu structure using the ENTER, DOWN and UP buttons.
- Scroll between menu items using the DOWN and UP buttons.
- Select any required menu option using the ENTER button.
- To return to the previous level in the menu structure without making a change, press the MENU button.
- To exit the menus, press the MENU button.

DMX address

The fixture can be controlled using signals sent by a DMX controller over 23 DMX channels. The DMX address, also known as the start channel, is the first channel used to receive instructions from the DMX controller. Each DMX-controlled fixture must have a DMX address set. If a fixture has its DMX address set to 1 and you want to use all 23 channels, then the next fixture can have a DMX address of 24, the next 47, then 70, and so on until the 512 channels in one DMX universe have all been allocated.

For independent control, each fixture must be assigned its own DMX channels. Two fixtures of the same type may share the same address, if identical behavior is desired. Address sharing can be useful for diagnostic purposes and symmetric control, particularly when combined with the inverse pan and tilt options.

To set the fixture's DMX address:

1. Select DMX ADDRESS in the control panel and press ENTER. The fixture's current DMX address will blink in the display.
2. Use the UP and DOWN buttons to select a new address (1 to 512).
3. Once the address has been selected, press ENTER to set it (or to return to the previous menu level without making a change, press MENU).

Personality

The MAC Axiom Hybrid provides several options that let you optimize the fixture for different applications in the PERSONALITY menu:

- The PAN/TILT menu lets you swap and/or invert pan and tilt.
- The PAN TIL T SPEED menu lets you set PAN/TILT to FAST (optimized for speed) or SMOOTH (optimized for smooth movement – useful for slow movements in long-throw applications).
- FOCUS TRACKING sets focus to automatically adapt to changes in zoom angle.
- AUTO LAMP ON gives three lamp strike options:
 - When set to OFF, the lamp remains off until a "lamp on" command is received via DMX.
 - When set to ON, the lamp strikes automatically after the fixture is powered on.
 - When set to DMX, the lamp strikes automatically when the fixture begins to receive DMX data.

Automatic lamp strikes are staggered to prevent all lamps from striking at once. A delay is determined by the fixture's DMX address.

No matter what the AUTOMATIC LAMP ON setting is, the lamp can be struck by sending a Lamp on command via DMX on the Fixture control/settings channel.

- DMX LAMP OFF and DMX RESET define whether the lamp can be powered off, or whether fixture or individual effects can be reset by sending a DMX command on the Fixture control/settings channels. If either of these settings are set to OFF, you can override this setting and cut lamp power or reset effects by applying a special combination of DMX values (see "DMX protocol" on page 20).
- EFFECT SHORTCUT determines whether the gobo wheel and color wheel take the shortest path between two positions (shortcuts enabled), crossing the open position if necessary, or always avoid the open position (shortcuts disabled).
- CMY MODE gives two options for using the CMY color mixing system:
 - CMY SNAP bypasses the first 10% of the color mixing range in order to avoid uneven color mixing at very low saturation levels. From 10% – 100% each color fades gradually.
 - CMY FADE gives control over the full color mixing range from 0% – 100%, giving gradual fading and freedom of color choice at all levels of saturation.
- DISPLAY offers the following options for the LCD display:
 - DISPLAY SLEEP determines whether the display remains on permanently, or goes into sleep mode 2, 5 or 10 minutes after the last press of the MENU button.
 - DISPLAY ROTATION lets you rotate the display through 180° so that it can be read easily if the fixture is installed with the head hanging below the base.
 - DISPLAY CONTRAST lets you define the contrast of the backlit graphic display. Set the contrast to a level from 1% to 100%.
- ERROR MODE enables or disables error warnings. If set to NORMAL, the display is activated and lights up if the fixture needs to report an error. If set to SILENT, the fixture does not light the display with error warnings but error messages can still be read when the display is activated manually.

Factory default

- FACTORY DEFAULT lets you reload the fixture's factory default settings.

Effect calibration is not affected, so any effects that have been re-calibrated will not be returned to factory calibration settings.

Information

The following fixture information can be called up in the display:

- POWER ON TIME provides two counters:
 - The TOTAL counter is not user-resettable and displays total hours powered on since manufacture.
 - The RESETTABLE counter is user-resettable and displays the number of hours the fixture has been powered on since the counter was last reset.
- LAMP ON TIME provides two counters:
 - The TOTAL counter is not user-resettable and displays total hours the lamp has been powered on since manufacture.
 - The RESETTABLE counter is user-resettable and displays the number of hours the lamp has been powered on since the counter was last reset. This counter is intended to allow you to monitor lamp life.

- LAMP STRIKES provides two counters:
 - The TOTAL counter is not user-resettable and displays the total number of lamp strikes since manufacture.
 - The RESETTABLE counter is user-resettable and displays the number of lamp strikes since the counter was last reset.
- SW VERSION displays the currently installed firmware (fixture software) version.
- RDM UID displays the fixture's factory-set unique ID for identification using an RDM-compatible controller.
- FANS provides separate status readouts from the fixture's cooling fans.
- TEMPERATURES displays a temperature readout from the ballast PCB.

DMX Live

The MAC Axiom Hybrid provides data on the DMX signal it is receiving in the DMX LIVE menu. This information can be useful for troubleshooting control problems.

- RATE displays the DMX refresh rate in packets per second. Values lower than 10 or higher than 45 may result in erratic performance, especially when using tracking control.
- QUALITY displays the quality of the received DMX data as a percentage of packets received. Values much below 100 indicate interference, poor connections, or other problems with the serial data link that are the most common cause of control problems.
- START CODE displays the DMX start code. Packets with a start code other than 0 may cause irregular performance.

The remaining options under DMX LIVE display the DMX values in a range from 0 – 255 that are being received on each channel.

Test

TEST activates effects in sequence, allowing you to test all functions, pan and tilt movement only, or effects only (i.e. without pan and tilt movement) without a DMX controller. To run a test:

1. Select a test type and press ENTER to start the test.
2. Press MENU button to stop the test.

Manual control

The MANUAL CONTROL menu lets you reset the MAC Axiom Hybrid, strike or douse the lamp, and operate the fixture without a DMX controller.

To execute commands in the MANUAL CONTROL menu

1. Select a menu item for the effect that you want to control.
2. Enter a value from 0 to 255 to apply a command. The menu items and values correspond to the commands listed in the DMX protocol on page 30.

Effects

This section gives an overview of the DMX-controllable effects that require particular explanation. See 'DMX protocol' on page 30 for a full list of the DMX channels and values used to control the different effects.

Dimming

The MAC Axiom Hybrid has full-range mechanical dimming.

Strobe effects

A range of strobe and pulse effects are available, with variable speed and random effects.

Cyan, Magenta, Yellow and CTO

The amount of cyan, magenta, yellow and CTO (Color Temperature Control Orange) applied to the MAC Axiom Hybrid's light output can be varied from zero to 100%.

Rotating gobos

The rotating gobo wheel in the MAC Axiom Hybrid provides nine rotating gobos plus an open position.

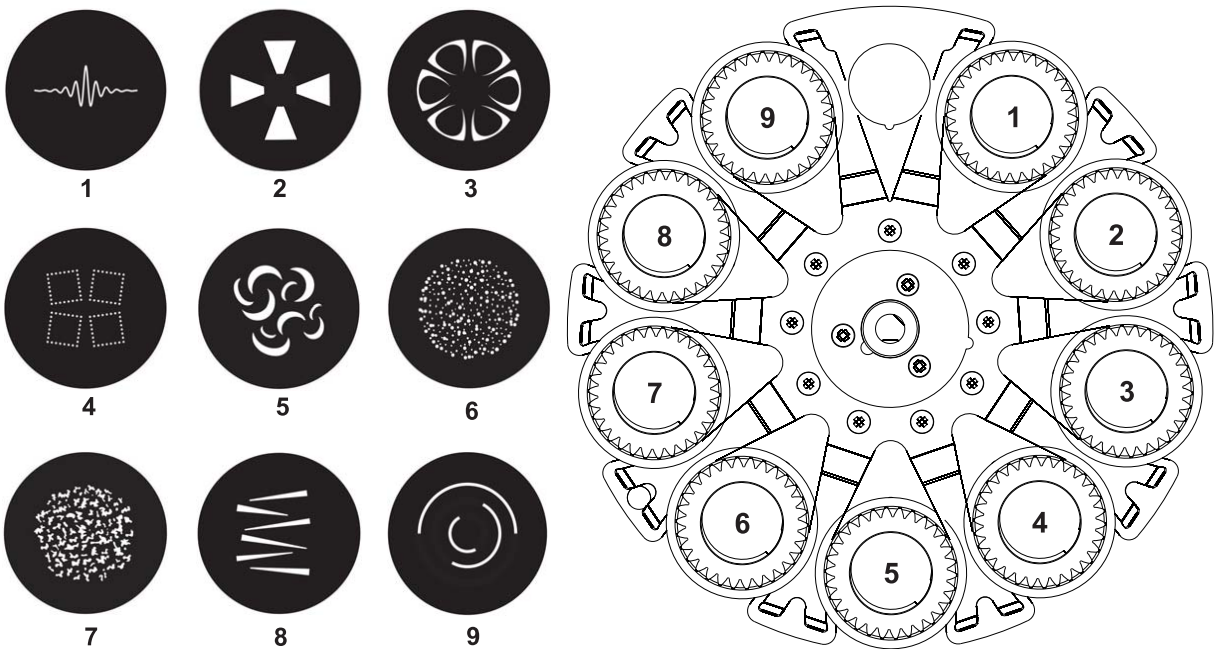

Gobo 1: Damped Wave
Gobo 4: Laser Squares
Gobo 7: Organic Delight

Gobo 2: 4 Luck Stakes
Gobo 5: Kite Surf
Gobo 8: Slice It

Gobo 3: Bite Me
Gobo 6: Dots in Space
Gobo 9: Circles

Rotating gobo wheel seen from front lens side

All gobos can be selected, indexed (positioned at an angle), rotated continuously and shaken (bounced). The entire gobo wheel can also be scrolled continuously or shaken.

The type of effect (gobo indexing, continuous gobo rotation, gobo shake or continuous wheel movement) is selected on one channel. Depending on what is selected on this first channel, the gobo indexed angle or gobo rotation speed/direction are set on the next channel. If gobo indexing is selected on the first channel, fine control of gobo indexed angle is available on the third control channel.

All gobos are interchangeable, but replacement gobos must match the dimensions, construction and quality of the gobos supplied as standard. The gobos are made of glass with special high temperature treatment and have 13,9 mm (+ 0 / - 0,1 mm) external diameter, 9 mm image area diameter.

Fixed gobos

The MAC Axiom Hybrid contains a gobo wheel with an open position, three iris positions, a pinspot effect, 12 fixed gobos, a frost glass and an animation effect that can be used in conjunction with rotating gobos:

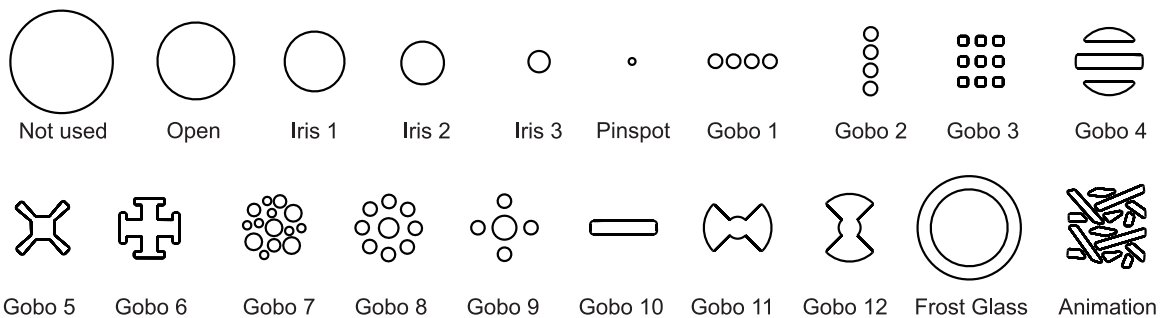
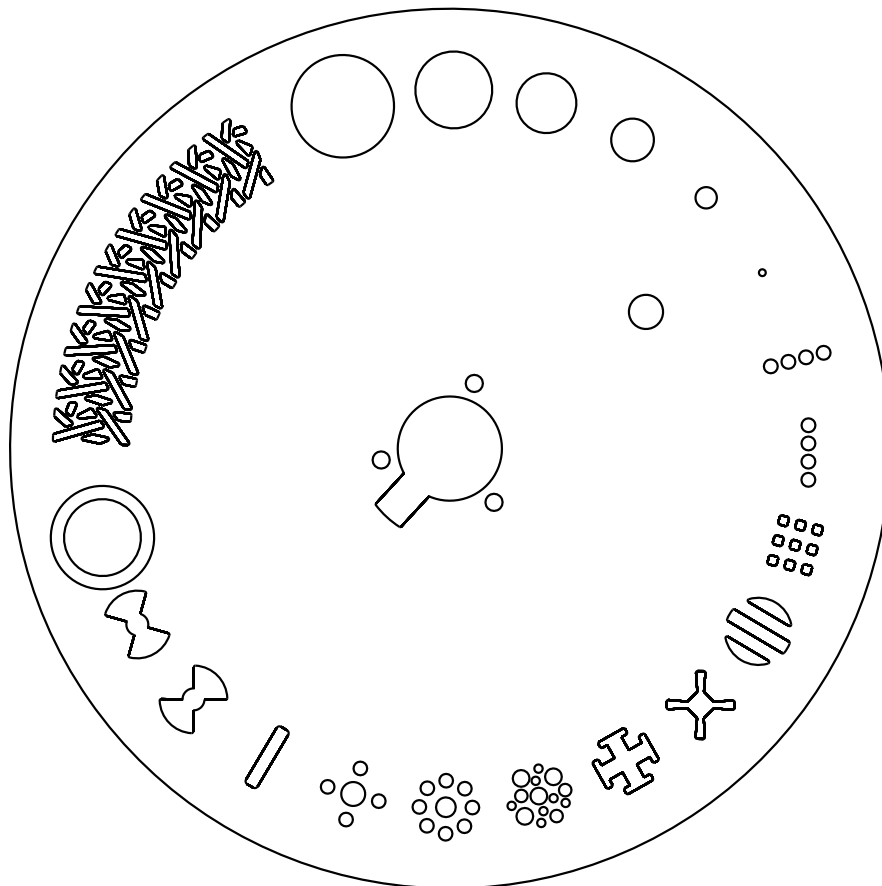

Fixed gobo wheel seen from front lens side

You can project any gobo or rotate the wheel clockwise or counter-clockwise at variable speeds.

Use the focus DMX channel to adjust the sharpness of gobo projections.

The frost glass and the gobo animation let you create animated effects by combining them with rotating gobos. When using frost glass or gobo animation, we recommend that you adjust focus to obtain the best results.

Color wheel

The fixture incorporates a color wheel with 16 dichroic color filters plus open. The colors can be applied as split colors or in full-color steps. The wheel can be rotated at varying speeds clockwise and counter-clockwise or at random at fast, medium or slow speed.

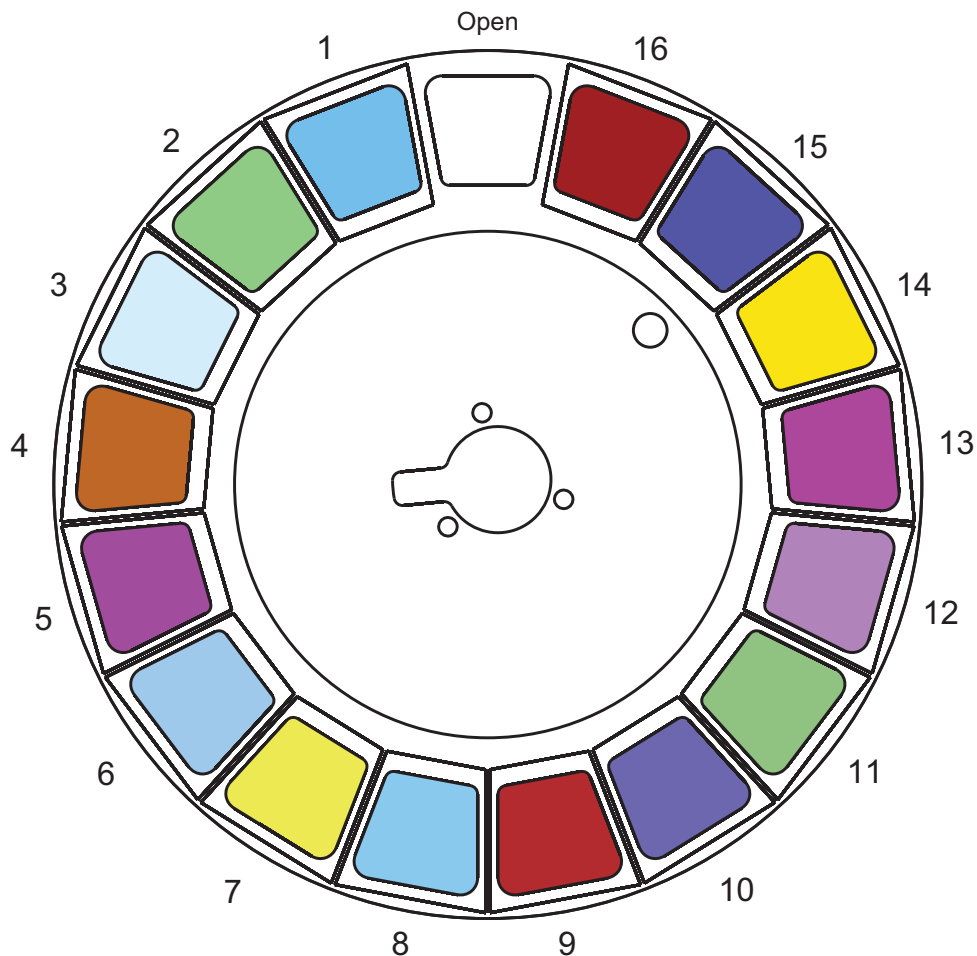

Open		Slot 9	Light red
Slot 1	Blue	Slot 10	Lavender
Slot 2	Light green	Slot 11	Dark green
Slot 3	Half CTB	Slot 12	Purple
Slot 4	Orange	Slot 13	Pink
Slot 5	Magenta	Slot 14	Yellow 1
Slot 6	Full CTB	Slot 15	Blue 101
Slot 7	Yellow 2	Slot 16	Red
Slot 8	Light blue		

MAC Axiom Hybrid color filters

Prisms and prism lineator

Either a 3-facet 15° prism or an 8-facet 15° rotating prism can be applied to the projection. Direction and speed of prism rotation are variable.

An innovative dynamic “prism lineator” zoom effect is available for whichever prism is active. This effect combines zoom with prism projections to alter the spread or overlap of the multiple projections from the prism.

Frost

A frost filter can be applied to the beam to provide a wash effect.

Focus/Zoom linking

Focus can be linked to zoom so that it automatically adjusts to match changes in zoom angle.

To link focus and zoom:

1. Adjust focus to obtain the required degree of sharpness.
2. Enable linking on the Fixture Control/Settings DMX channel or in FOCUS TRACKING in the control panel PERSONALITY menu.

Pan and tilt

The fixture’s moving head can be panned through 540° and tilted through 260° using coarse and fine control channels.

Service and maintenance



Warning! Read 'Safety information' on page 4 before servicing the fixture.

Refer any service or repair operation not described in this manual to an authorized Martin® service technician.

Disconnect mains power before cleaning or servicing the fixture.

Service the fixtures in an area where there is no risk of injury from falling parts, tools or other materials.

Installation, on-site service and maintenance can be provided worldwide by the Martin Professional Global Service organization and its approved agents, giving owners access to Martin®'s expertise and product knowledge in a partnership that will ensure the highest level of performance throughout the product's lifetime. Please contact your Martin® supplier for details.

We recommend that you magnetize screwdrivers to help you avoid dropping screws into the fixture.

Cleaning

Excessive dust, smoke fluid, and particle buildup degrades performance, causes overheating and will damage the fixture. Damage caused by inadequate cleaning or maintenance is not covered by the product warranty.

The cleaning of external optical lenses must be carried out periodically to optimize light output. Cleaning schedules for lighting fixtures vary greatly depending on the operating environment. It is therefore impossible to specify precise cleaning intervals for the fixture. Environmental factors that may result in a need for frequent cleaning include:

- Use of smoke or fog machines.
- High airflow rates (near air conditioning vents, for example).
- Presence of cigarette smoke.
- Airborne dust (from stage effects, building structures and fittings or the natural environment at outdoor events, for example).

If one or more of these factors is present, inspect fixtures within their first 100 hours of operation to see whether cleaning is necessary. Check again at frequent intervals. This procedure will allow you to assess cleaning requirements in your particular situation. If in doubt, consult your Martin® supplier about a suitable maintenance schedule.

Use gentle pressure only when cleaning, and work in a clean, well-lit area. Do not use any product that contains solvents or abrasives, as these can cause surface damage.

To clean the fixture:

1. Disconnect the fixture from power and allow it to cool for at least 20 minutes.
2. Vacuum or gently blow away dust and loose particles from the outside of the fixture and the air vents at the back and sides of the head and in the base with low-pressure compressed air.
3. Clean optical components by wiping gently with a soft, clean lint-free cloth moistened with a weak detergent solution. Do not rub the surface hard: lift particles off with a soft repeated press. Dry with a soft, clean, lint-free cloth or low-pressure compressed air. Remove stuck particles with an unscented tissue or cotton swab moistened with glass cleaner or distilled water.
4. Check that the fixture is dry before reapplying power.

Access inside the head

For access to the components inside the head to allow lamp replacement or service of optical components:

1. If the fixture has been in use, power the lamp off but leave the fixture powered on for at least 10 minutes so that the cooling fans cool the lamp. Disconnect the fixture from power and allow it to cool for 20 minutes.
2. Apply the tilt lock (see “Tilt lock” on page 8).
3. Use a flat-bladed screwdriver to release the three quarter-turn fasteners (arrowed) on each head cover and lift the cover up from the head:

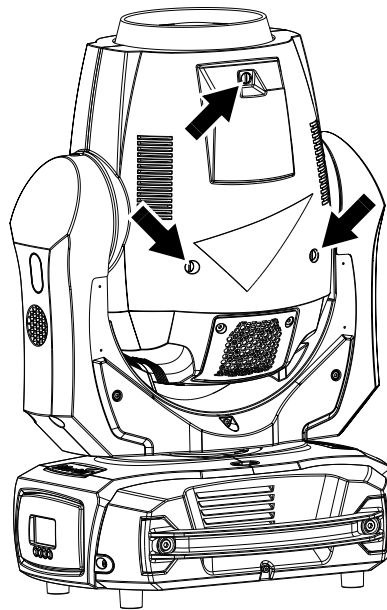

5. For each head cover, slide the silicone sleeve (arrowed) down the cover's safety wire and unhook the safety wire from the head, and then lift the cover away from the fixture:

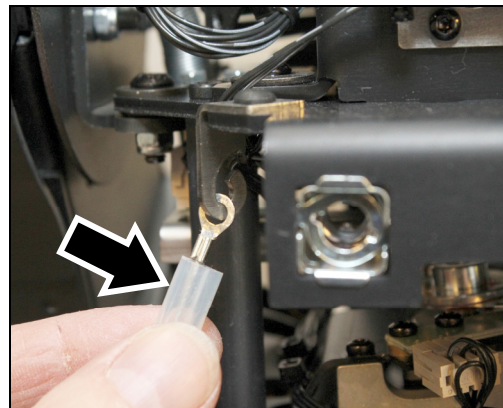
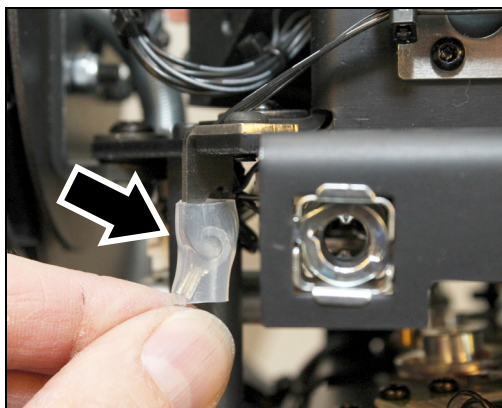

6. After completing service, reinstall the safety wires and head covers using the instructions above as a guide and check that the fixture is secure before reapplying power.

Lamp replacement



Warning! Read 'Lamp safety' on page 6 before servicing the lamp.

Important! Replace the lamp before it reaches the end of the specified lifetime given under 'Lamp' on page 41, or the lamp may explode in the fixture and cause damage that is not covered by the product warranty.

Replacing the lamp

The lamp must be perfectly clean. Do not touch the lamp's glass bulb with bare hands. If this happens, clean the lamp with an alcohol wipe and dry it with a clean, lint-free cloth.

To replace the lamp:

1. Obtain an Osram SIRIUS HRI 440W lamp.
2. Remove the head covers (see 'Access inside the head' on page 22).
3. Put on protective glasses and gloves.
4. Unscrew the four Torx 10 screws (arrowed) from the lamp compartment cover and then remove the cover:

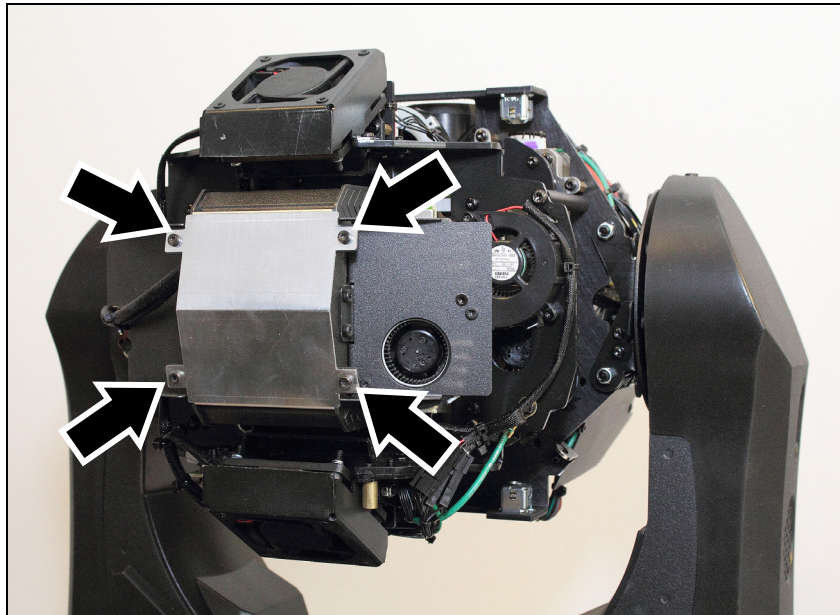

5. Disconnect the lamp wires from the lamp terminals (arrowed):

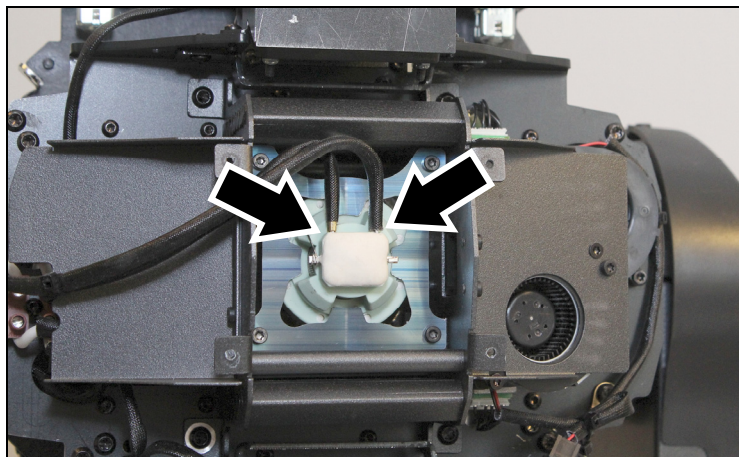

6. Loosen the four Torx 10 screws (arrowed) on the metal lampholder plate. Lift the plate and the lamp out of the fixture:

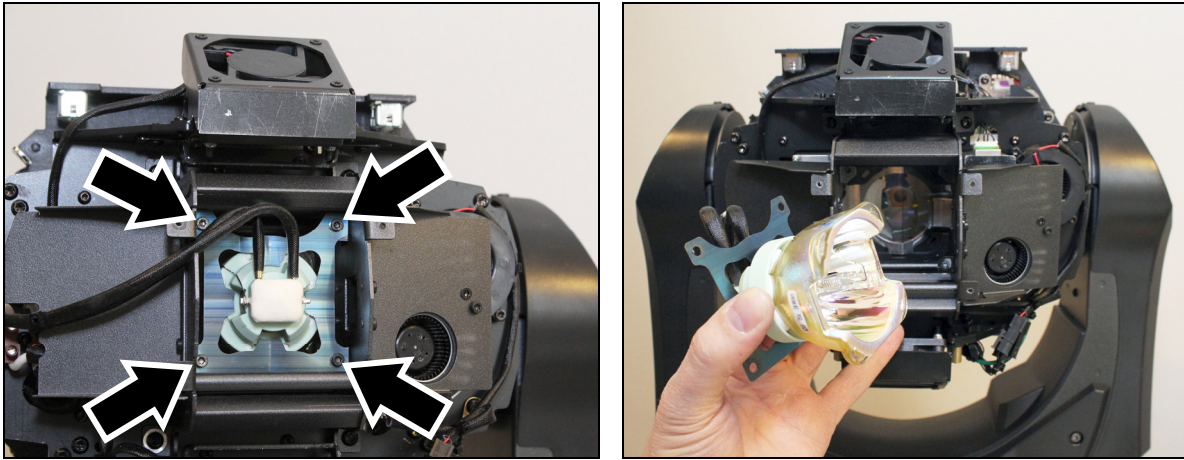

7. To install the new lamp, follow the above procedure in reverse, noting the following points:

Install the lampholder plate with the convex side facing the lamp:

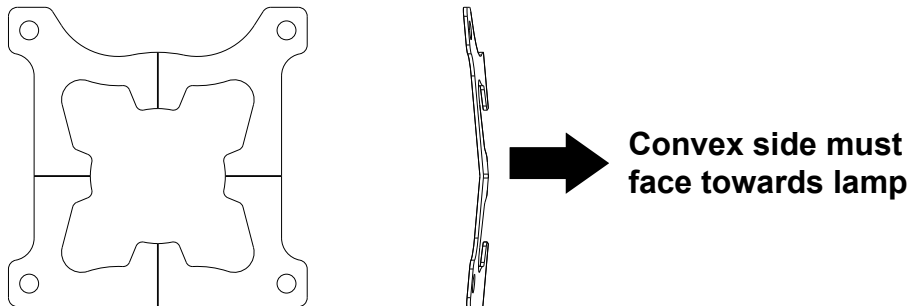

Install the new lamp with the lamp terminals facing the same way as for the old lamp, towards the lamp wire cutout (arrowed) in the side of the lamp compartment. Route the lamp wires through the cutout as shown when you fasten the lamp and lampholder plate into position:

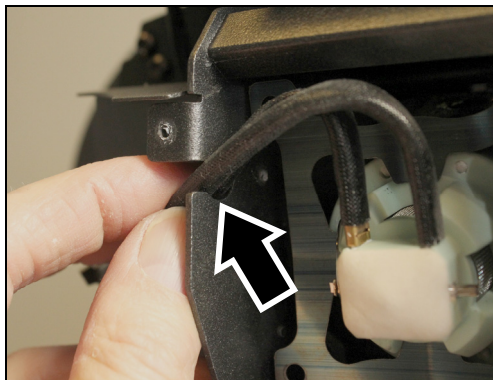

8. When the fixture is reassembled and secure, check that the tilt lock is released, power the fixture on and reset the Lamp On Time counter in the control menu.

Replacing the prism

To replace the prism:

1. Stand the fixture on its base on a stable work surface.
2. Remove the head covers (see 'Access inside the head' on page 22).
3. Point the head upwards and apply the tilt lock.
4. Note the positions of the four locating keys for the front glass assembly. You will need to install the front glass so that the slots in the front glass assembly fit onto these keys when you reinstall the front glass. The photo on the right below shows one of the keys with the front glass removed:

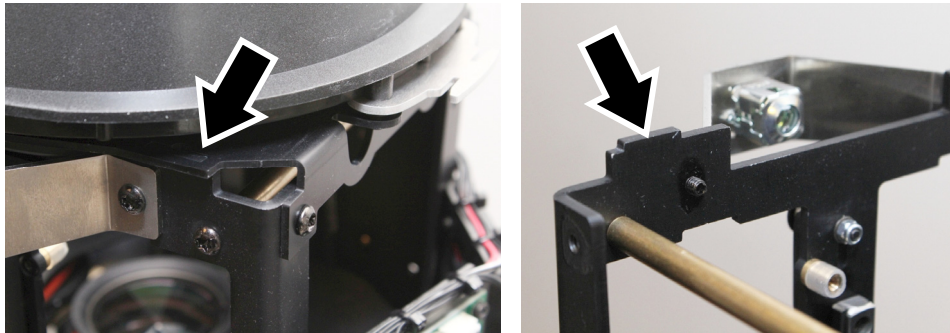

5. Remove the four Torx 20 screws from the front glass assembly and lift the front glass assembly off the fixture:

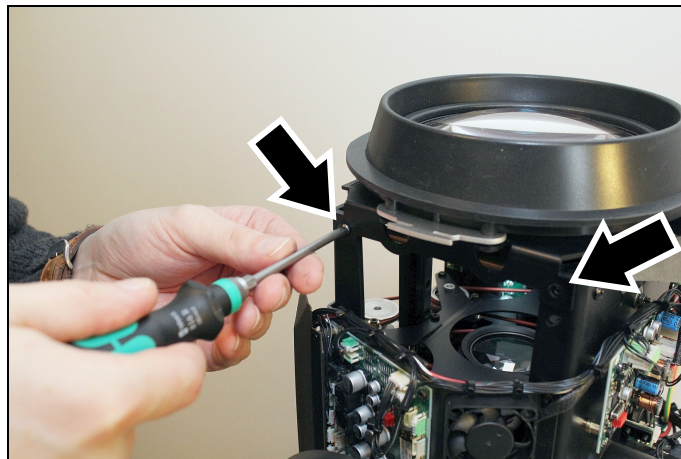

6. Lift the prism car up towards the top of the head so that you can reach the prism with a screwdriver:

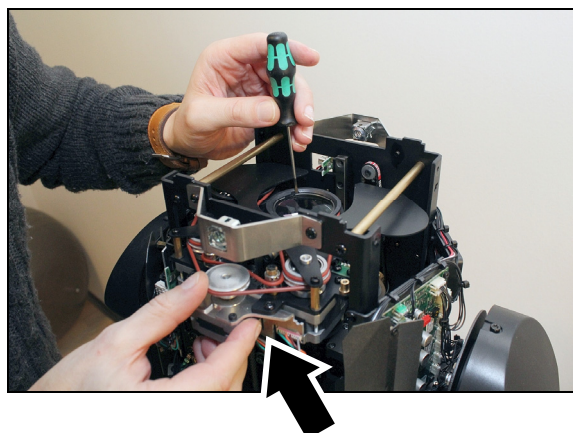

7. Prepare to hold the circlip and washer that hold the prism in place so that you do not lose these two items when you release the circlip. Use a flat-bladed screwdriver in the cutout (arrowed) in the prism holder to lever the circlip out of its groove. Lift the circlip and its washer away and keep these two components for reuse:

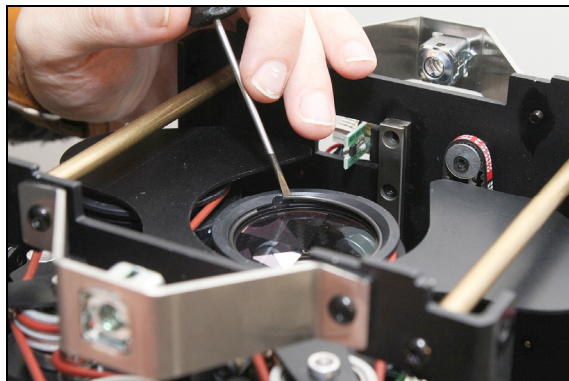
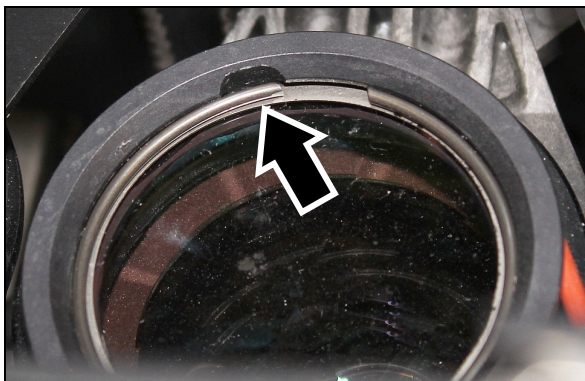

8. Wearing a clean, dry, lint-free glove, lift the prism out of its holder:

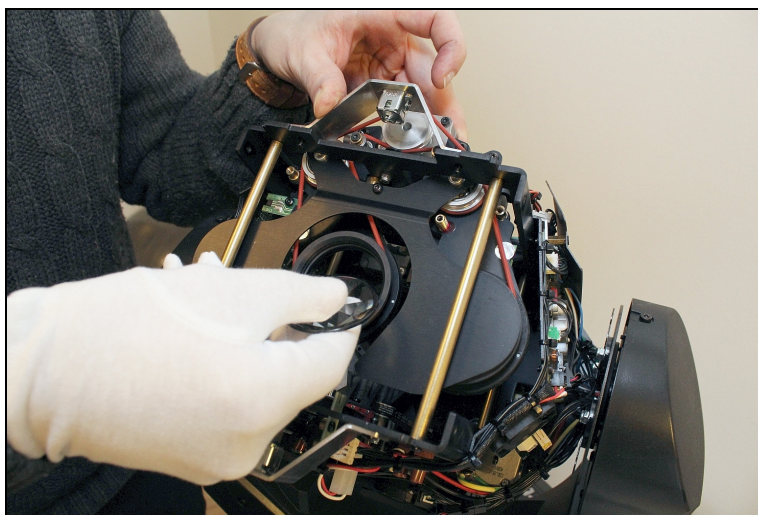

9. Reassembly is the reverse of the above procedure. Install the prism with the faceted side (arrowed) facing downwards towards the lamp and the flat side of the prism facing up towards the front glass:

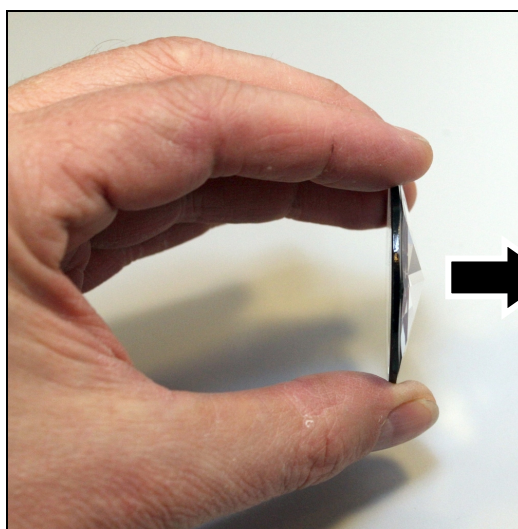

Facetted side must face towards lamp

10. Place the prism in the holder first, then the washer, and then install the circlip on top of the washer:

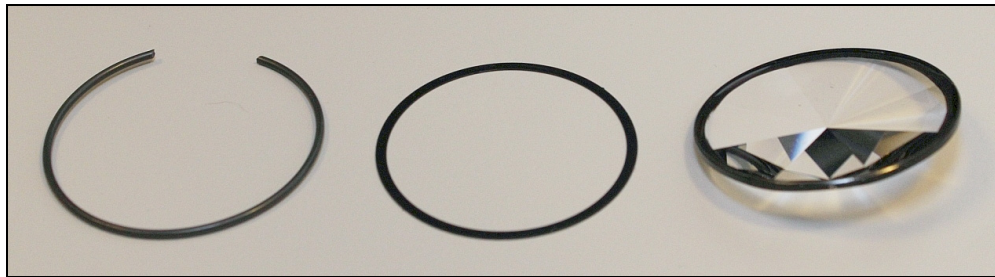

Circlip (on top)

Washer (under circlip)

Prism (under washer)

11. Check that the head cover safety wires are correctly installed during reassembly. Check that the fixture is secure before reapplying power.

Replacing a rotating gobo

Gobo removal

To remove a rotating gobo:

1. Stand the fixture on its base on a stable work surface.
2. Remove the head covers (see 'Access inside the head' on page 22).
3. Tilt the head so that you can access the rotating gobo wheel as shown below. Rotate the wheel by hand until you have access to the gobo that you want to replace (arrowed):

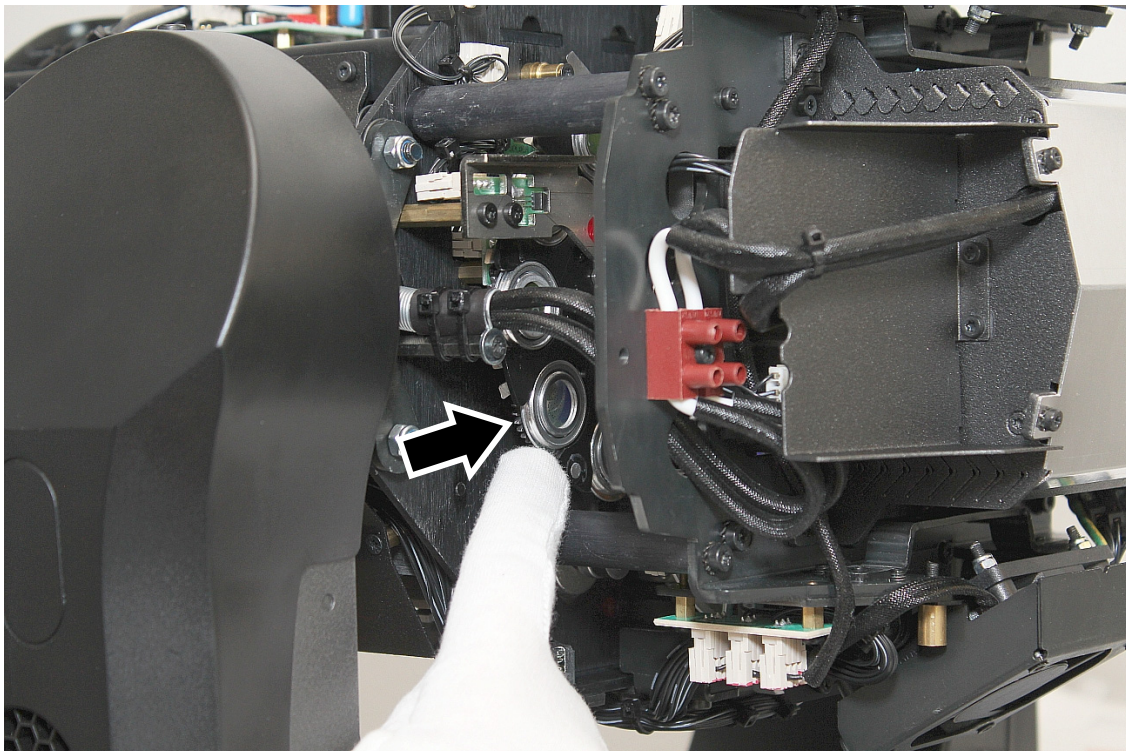

4. Wearing a clean, dry, lint-free glove, press the goboholder away from the wheel against the arms (arrowed) of its retaining clip, then slide the goboholder out of the wheel:

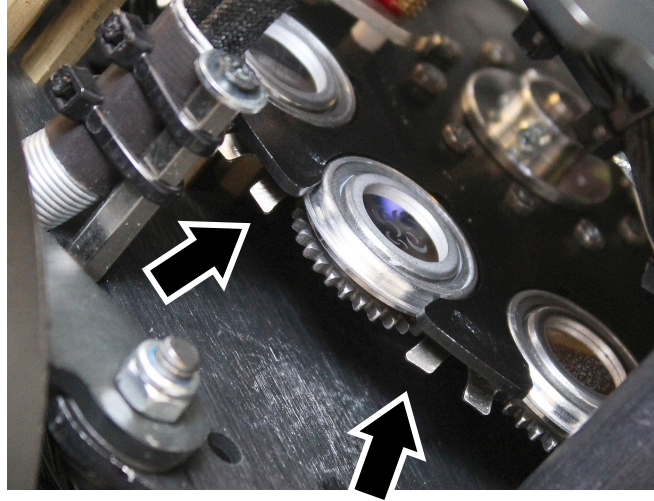

- Using your thumb, press the gobo firmly through from the back of the goboholder to release the circlip and gobo from the holder. Keep the gobo as flat as possible while pressing.

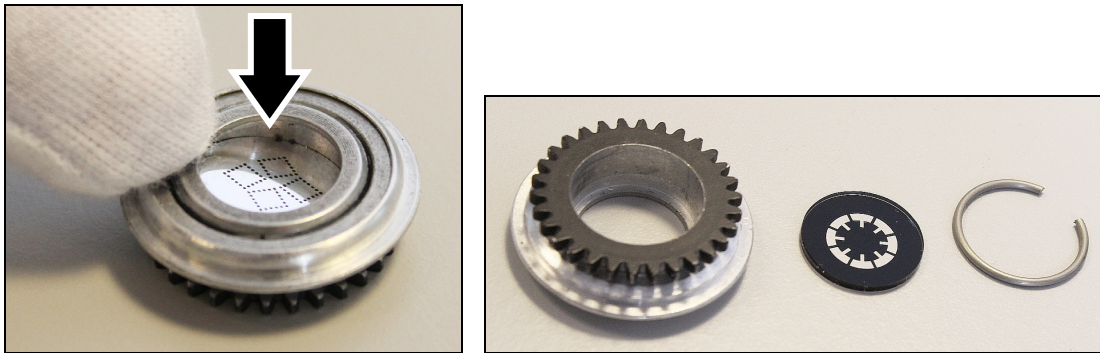

Gobo installation

To install a new gobo:

- Place the goboholder on a clean work surface with the gear teeth facing upwards. Wearing a clean, lint-free glove, push the gobo **fully** into the the goboholder with the **dark side of the gobo facing upwards, towards the teeth**. Press the circlip (arrowed) down into the goboholder. Ensure that the gobo remains **flat at the bottom of the goboholder** while you install the circlip, or the gobo may become wedged in a crooked position and you may damage it.

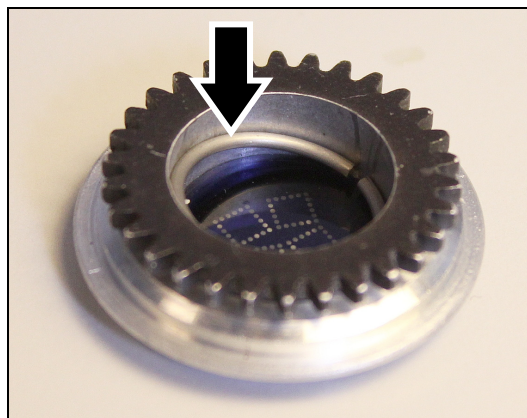

- Use a flat-bladed screwdriver to press the circlip down until **all of the circlip is sitting flat against the gobo**. Be careful not to damage the gobo with the screwdriver. Then turn the gobo

over and check that the shiny side of the gobo is sitting flat against the rim of the goboholder (arrowed):

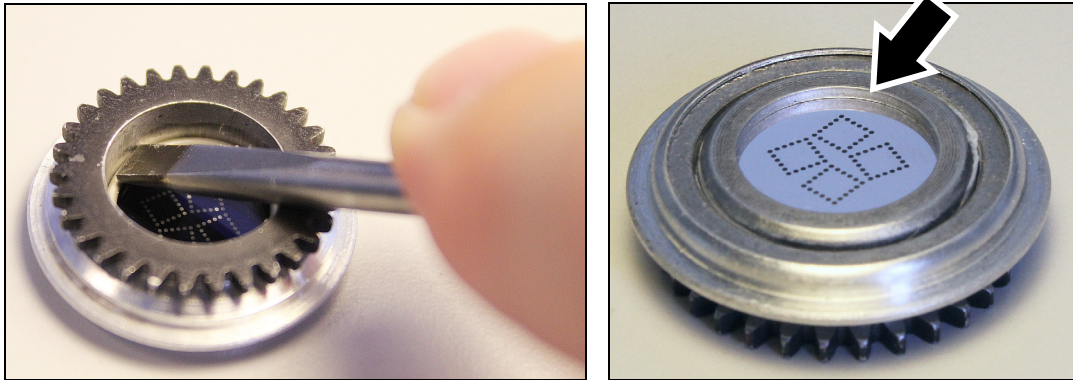

3. Reinstall the goboholder in the rotating gobo wheel by sliding it under the arms of its clip. Check that the goboholder is correctly seated in its cutout in the rotating gobo wheel. Check that the teeth of the goboholder engage in the teeth of the rotating gobo activation wheel.
4. The rest of the reassembly procedure is the reverse of disassembly. Check that the head cover safety wires are installed securely during reassembly. Check that the fixture is secure before reapplying power.

Handling gobos

Handling and storing gobos requires special care:

- Store all gobos in a dust-free environment with approx. 50% humidity.
- Always use clean gloves when handling gobos.
- Avoid scratching coated and uncoated sides.
- Avoid touching the other gobos when taking out a gobo from a rack: the sharp edge of one gobo can scratch the others.
- Clean the coated side of gobos with dust and oil-free compressed air only.
- Clean the uncoated side of gobos with photographic quality lens-cleaner and optics cleaning tissues. Use a repeated dabbing action rather than a rubbing action.
- Never place a gobo with the coated side face-down on any surface.
- Mount the gobo with the matted coating towards the lens.

Replacing the primary fuse

If the fixture is completely dead, the fixture's primary fuse may have blown and it may be necessary to install a new fuse. This fuse is located in a fuseholder next to the AC mains power IN socket on the connections panel. See 'Fixture overview' on page 12.

To change the fuse:

1. Disconnect the fixture from power and allow it to cool for at least 60 minutes.
2. Use a large flat-bladed screwdriver to unscrew the cap of the fuseholder.
3. Replace the fuse with one of the same type and rating only (250 V, T 8 A, slow blow).
4. Reinstall the fuseholder cap before reapplying power.

DMX protocol

Channel	Value	Function	Fade type	Default Value
1	0-19 20-49 50-180 181-190 191-200 201-210 211-255	Strobe Shutter closed Shutter open Strobe (slow → fast) Opening pulse (slow → fast) Closing pulse (slow → fast) Shutter open Random strobe (slow → fast)	Snap	30
2	0-255	Dimmer Closed → open	Fade	0
3	0-255	Cyan 0 → 100%	Fade	0
4	0-255	Magenta 0 → 100%	Fade	0
5	0-255	Yellow 0 → 100%	Fade	0
6	0-255	CTO Open → warm	Fade	0
7	0 1-8 9 10-17 18 19-26 27 28-35 36 37-44 45 46-53 54 55-62 63 64-71 72 73-80 81 82-89 90 91-98 99 100-107 108 109-116 117	Color wheel <i>Continuous scrolling (split colors)</i> Open Open → Slot 1 Slot 1 Slot 1 → Slot 2 Slot 2 Slot 2 → Slot 3 Slot 3 Slot 3 → Slot 4 Slot 4 Slot 4 → Slot 5 Slot 5 Slot 5 → Slot 6 Slot 6 Slot 6 → Slot 7 Slot 7 Slot 7 → Slot 8 Slot 8 Slot 8 → Slot 9 Slot 9 Slot 9 → Slot 10 Slot 10 Slot 10 → Slot 11 Slot 11 Slot 11 → Slot 12 Slot 12 Slot 12 → Slot 13 Slot 13	Snap	0

7 (cont.)	118-125	Slot 13 → Slot 14	Snap	0
	126	Slot 14		
	127-134	Slot 14 → Slot 15		
	135	Slot 15		
	136-143	Slot 15 → Slot 16		
	144	Slot 16		
	145-152	Slot 16 → Open		
	153-162	Open		
		<i>Stepped scrolling (full colors)</i>		
	163	Slot 1		
	164	Slot 2		
	165	Slot 3		
	166	Slot 4		
	167	Slot 5		
	168	Slot 6		
	169	Slot 7		
	170	Slot 8		
	171	Slot 9		
	172	Slot 10		
	173	Slot 11		
	174	Slot 12		
	175	Slot 13		
	176	Slot 14		
	177	Slot 15		
	178	Slot 16		
	179-192	Open		
		<i>Continuous wheel rotation</i>		
193-214	CW, fast → slow			
215-221	Stop (wheel stops at its current position)			
222-243	CCW, slow → fast			
	<i>Random slots</i>			
244-247	Fast			
248-251	Medium			
252-255	Slow			

8	<p>0-2 3-6 7-10 11-14 15-19 20-23 24-27 28-31 32-35 36-40</p> <p>41-44 45-48 49-52 53-56 57-60 61-64 65-68 69-71 72-80</p> <p>81-90 91-100 101-110 111-120 121-130 131-140 141-150 151-160 161-170 171-200</p> <p>201-228 229-255</p>	<p>Rotating gobo wheel</p> <p><i>Gobo indexing (set angle on channels 9 and 10)</i></p> <p>Open Gobo 1 Gobo 2 Gobo 3 Gobo 4 Gobo 5 Gobo 6 Gobo 7 Gobo 8 Gobo 9</p> <p><i>Gobo rotation (set rotation speed and direction on channels 9 and 10)</i></p> <p>Gobo 1 Gobo 2 Gobo 3 Gobo 4 Gobo 5 Gobo 6 Gobo 7 Gobo 8 Gobo 9</p> <p><i>Gobo shake (set indexed angle on channels 9-10)</i></p> <p>Gobo 1 shake, 25° slow → 10° fast Gobo 2 shake, 25° slow → 10° fast Gobo 3 shake, 25° slow → 10° fast Gobo 4 shake, 25° slow → 10° fast Gobo 5 shake, 25° slow → 10° fast Gobo 6 shake, 25° slow → 10° fast Gobo 7 shake, 25° slow → 10° fast Gobo 8 shake, 25° slow → 10° fast Gobo 9 shake, 25° slow → 10° fast Open</p> <p><i>Continuous gobo wheel rotation</i></p> <p>CW fast → slow CCW slow → fast</p>	Snap	0
9-10	<p>0-65535</p> <p>0-600 601-32130 32131-32895 32896-64515 64516-65535</p>	<p>Gobo indexing angle / gobo rotation direction and speed, 16-bit (MSB and LSB)</p> <p><i>Gobo indexing</i></p> <p>Indexed angle (0° index at 32768)</p> <p><i>Gobo rotation</i></p> <p>No rotation (gobo indexed at 0°) Rotation CW fast → CW slow No rotation (gobo stops at its current position) Rotation CCW slow → CCW fast No rotation (gobo indexed at 90°)</p>	Fade	32768

11	0-20	Fixed gobo wheel	Snap	0
	21-30	<i>Gobo selection (stepped gobo wheel scroll)</i>		
	31-40	Open		
	41-50	Iris 1		
	51-60	Iris 2		
	61-70	Iris 3		
	71-80	Pinspot		
	81-90	Gobo 1		
	91-100	Gobo 2		
	101-110	Gobo 3		
	111-120	Gobo 4		
121-130	Gobo 5			
131-140	Gobo 6			
141-150	Gobo 7			
151-160	Gobo 8			
161-170	Gobo 9			
171-180	Gobo 10			
181-190	Gobo 11			
	Gobo 12			
	Frost			
	<i>Animation</i>			
191-200	Indexed			
201	Slow			
202	Medium			
203	Fast			
	<i>Continuous rotation</i>			
204-220	CW, fast → slow			
221-226	Stop (wheel stops at its current position)			
227-243	CCW, slow → fast			
	<i>Random slots</i>			
244-247	Fast			
248-251	Medium			
252-255	Slow			
12	0-127 128-255	Frost Disabled Enabled	Snap	0
13	0-10	Prism deployment Open	Snap	0
	11-20 21-30	<i>Position 1 (between zoom and focus)</i> 3-facet 8- facet		
	31-40 41-255	<i>Position 2 (in front of zoom)</i> 3-facet 8- facet		
14	0-2	Prism rotation No rotation (prism stops at its current position)	Fade	0
	3-126	Rotating CW fast → CW slow		
	127-129	No rotation (prism stops at its current position)		
	130-253 254-255	Rotating CCW slow → CCW fast No rotation (prism stops at its current position)		
15	0-255	Prism lineator Wide → narrow	Fade	128

16	0-255	Zoom Wide → narrow	Fade	128
17-18	0-65535	Focus, 16-bit (MSB and LSB) Infinity → near	Fade	32768
19-20	0-65535	Pan, 16-bit (MSB and LSB) Left → right	Fade	32768
21-22	0-65535	Tilt, 16-bit (MSB and LSB) Forward → backward	Fade	32768
23	0-9 10-14 15 16-17 18 19-27 28 29 30 31 32 33 34 35 36-39 40-44 45-51 52 53 54-255	Fixture control settings <i>No function</i> Reset fixture <i>No function</i> Reset head motors only Reset pan and tilt <i>No function</i> Pan and tilt speed = FAST (default) Pan and tilt speed = SMOOTH Parameter shortcuts = ON (default) Parameter shortcuts = OFF Disable focus tracking Enable focus tracking CMY Snap mode (default) CMY Fade mode <i>No function</i> Lamp = ON Lamp = OFF Turn on onboard display Turn off onboard display <i>No function</i>	Snap	0

Control menus

To access the control menus, press the MENU button. Use the UP and DOWN buttons to navigate the menus. Select any required menu option using the ENTER button. For more information, see 'Using the control panel' on page 14.

Default fixture settings are shown in **bold**.

Menu level 1	Menu level 2	Menu level 3	Menu level 4	Notes (Default settings in bold print)	
DMX ADDRESS	1-490			Set fixture's DMX address	
PERSONALITY	PAN/TILT	PAN INVERT	ON/OFF	Reverse DMX pan control: from right to left	
		TILT INVERT	ON/OFF	Reverse DMX tilt control: from down to up	
	PAN TILT SPEED	FAST		Optimize pan/tilt movement for speed	
		SMOOTH		Optimize pan/tilt movement for smoothness	
	FOCUS TRACKING	ENABLED		Enables zoom focus linking	
		DISABLED		Disables zoom focus linking	
	AUTO LAMP ON	OFF		Automatic lamp striking disabled	
		ON		Lamp strikes automatically within 60 seconds of fixture being powered on	
		DMX		Lamp strikes automatically when the fixture receives a DMX signal	
	DMX LAMP OFF	ON		Lamp can be powered off via DMX	
		OFF		Lamp cannot be powered off via DMX	
	DMX RESET	ON		Fixture can be reset via DMX	
		OFF		Fixture cannot be reset via DMX	
	EFFECT SHORTCUT	ON		Effects take shortest route during changes, crossing open positions if necessary.	
		OFF		Effects avoid open positions during effects changes	
	CMY MODE	SNAP		CMY colors jump directly from 0 to 10% and then fade gradually to 100%	
		FADE		CMY colors fade gradually from 0-100%	
	DISPLAY	DISPLAY SLEEP	ON		Onboard display panel permanently on
			2 MINUTES		Display goes into sleep mode 2 minutes after last key press
			5 MINUTES		Display goes into sleep mode 5 minutes after last key press
			10 MINUTES		Display goes into sleep mode 10 minutes after last key press
		DISPLAY ROTATION	AUTOMATIC		Display flips vertically automatically depending on fixture orientation.
			NORMAL		Display orientation normal
ROTATE 180				Display orientation inverted	
DISPLAY CONTRAST		15-40	Adjust contrast of display (default = 25)		
ERROR MODE	NORMAL		Enable error messages and warnings in display		
	SILENT		Disable error messages and warnings in display		
FACTORY DEFAULT	LOAD	ARE YOU SURE?	YES/NO	Return all settings (except calibrations) to factory default	

INFORMATION	POWER ON TIME	TOTAL	0 - xxx HR	Hours fixture has been powered on since manufacture (not user-resettable)
		RESETTABLE	CLEAR COUNTER ? YES/NO	Hours fixture has been powered on since last counter reset
	LAMP ON TIME	TOTAL	0 - xxx HR	Hours of lamp use since manufacture (not user-resettable)
		RESETTABLE	CLEAR COUNTER ? YES/NO	Hours of lamp use since last counter reset (user-resettable)
	LAMP STRIKES	TOTAL	0 - xxx	Number of times lamp has been struck since manufacture (not user-resettable)
		RESETTABLE	CLEAR COUNTER ? YES/NO	Number of times lamp has been struck since last counter reset (user-resettable)
	SW VERSION	x.x.x		Currently active software version
	RDM UID	4D50:xxxxxx		Fixture's unique RDM ID
	FANS	BASE	xx.x V	Current voltages of cooling fans for lamp (four fans), gobo wheels and shutter blades
		LAMP 60	xx.x V	
LAMP 40		xx.x V		
LAMP F		xx.x V		
LAMP B		xx.x V		
GOBO		xx.x V		
SHUTTER	xx.x V			
TEMPERATURES	BALLAST	x C	Temperature in °C of ballast PCB	
DMX LIVE	RATE	0-45 HZ		DMX transmission speed in packets per second
	QUALITY	0-100 %		Percent of packets received
	1 STROBE ... 23 FIXTURE CONTROL	0-255		DMX value currently being received on DMX channels 1 – 23 in sequence
TEST	ALL			Run test sequence of all effects, of pan, tilt or of single effects. Press Menu button to stop test.
	PAN			
	TILT			
	STROBE			
	DIMMER			
	CMY			
	CTO			
	COLOR			
	GOBO WHEEL			
	GOBO ROTATION			
	FIXED GOBO			
	FROST			
	PRISM 3F			
	PRISM 8F			
	PRISM LIN			
ZOOM				
FOCUS				
MANUAL CONTROL	RESET	HEAD MOTORS		Reset head motors only
		PAN TILT		Reset pan and tilt only
		ALL MOTORS		Reset all motors
	LAMP ON/OFF	ON/OFF		Manually strike/douse lamp
	STROBE	0-255		Set shutter/strobe effect (default = 30)
	DIMMER	0-255		Set dimmer opening (default = 255)
	CYAN	0-255		Add cyan
	MAGENTA	0-255		Add magenta
	YELLOW	0-255		Add yellow
	CTO	0-255		Adjust color temperature control (add warmth)
	COLOR WHEEL	0-255		Select color filter
	GOBO W SEL	0-255		Select rotating gobo
	GOBO W I/R MSB	0-255		Adjust rotating gobo indexing/rotation
GOBO W I/R LSB	0-255		Adjust rotating gobo indexing/rotation, fine	

MANUAL CONTROL (contd.)	FIXED GOBO	0-255	Select fixed gobo
	FROST	0-255	Frost insertion
	PRISM	0-255	Prism insertion
	PRISM ROTATION	0-255	Set prism rotation
	PRISM LINEATOR	0-255	Set prism lineator position
	ZOOM	0-255	Set zoom (default = 128)
	FOCUS MSB	0-255	Set focus (default = 128)
	FOCUS LSB	0-255	Set focus fine (default = 128)
	PAN MSB	0-255	Set pan angle (default = 128)
	PAN LSB	0-255	Set pan angle, fine (default = 128)
	TILT MSB	0-255	Set tilt angle (default = 128)
	TILT LSB	0-255	Set tilt angle, fine (default = 128)
	CONTROL	0-255	Apply commands on control / settings channel
SERVICE	ERROR LIST	Empty or up to 20 errors	Display any errors in memory
	PT FEEDBACK	ON	Enable pan/tilt position feedback systems
		OFF	Disable pan/tilt position feedback

Error messages

Error:	Appears when:
PAN LOCKED TILT LOCKED	Pan motor or tilt motor locked.
DATA ERROR	Parameter storage problem. Pan/tilt board memory damaged.
BUS 10 MOTORS MASTER BUS 10 MOTORS SLAVE	Communication problem between 10 motors board master or slave and pan & tilt board. Wiring fault or 10 motors board damage possible.
BUS AUX FANS	Communication problem between fans control board and pan & tilt board. Wiring fault or fans control board damage possible.
3 F. PRISM ERROR 8 F. PRISM ERROR COLOUR WHEEL ERROR CTO ERROR CYAN ERROR FIXED GOBO ERROR FOCUS ERROR GOBO ERROR GOBO INDEX ERROR MAGENTA ERROR PAN ERROR PRISM LINEATOR ERROR SHUTTER ERROR TILT ERROR YELLOW ERROR ZOOM ERROR	Effect position error (may appear when powering on or resetting fixture). Sensor or component damage possible.
LAMP STARTUP FAIL	No lamp detected or lamp wiring fault.
LAMP ON OVER 1500 HOURS	The lamp has exceeded 1500 hours of use. Change the lamp as directed in this manual. Continuing to use the lamp increases the risk of a lamp explosion.

Troubleshooting

This section describes a few common problems that may occur during operation and provides some suggestions for easy troubleshooting:

Symptom	Potential cause	Remedies
No light from fixture, or fans not working.	Power supply issue, such as blown fuse, faulty connector or damaged cable.	Check all power connections and cables. Replace fixture's primary fuse.
One of the control channels is unresponsive or only responds intermittently.	Damaged step motor or cable connection between the head and body.	Contact your Martin® supplier for assistance.
Lamp cuts out intermittently	Incorrect mains voltage or internal temperature is too high.	Check mains voltage. Check that there is free airflow around the fixture and that the ambient temperature does not exceed the permitted maximum. Clean fixture, especially cooling fans and vents. If problem persists, contact your Martin® supplier for assistance.
Fixture does not respond or does not respond correctly to DMX control.	Incorrect DMX addressing. Fault on DMX link.	Ensure that fixture's DMX address matches address set on DMX control device. Check that DMX link is terminated. Check that all devices on DMX link use standard DMX polarity. Check for faulty devices on DMX link (bypass devices one by one). Check for faulty DMX control device (try to control the fixture with another DMX control device). Move or shield DMX link if it is very close to an unshielded high-voltage installation.

Specifications

Physical

Weight.....	24.8 kg (54.7 lbs.)
Width.....	414 mm (16.3 ins.)
Length.....	399 mm (15.8 ins.)
Height.....	616 mm (24.3 ins.)

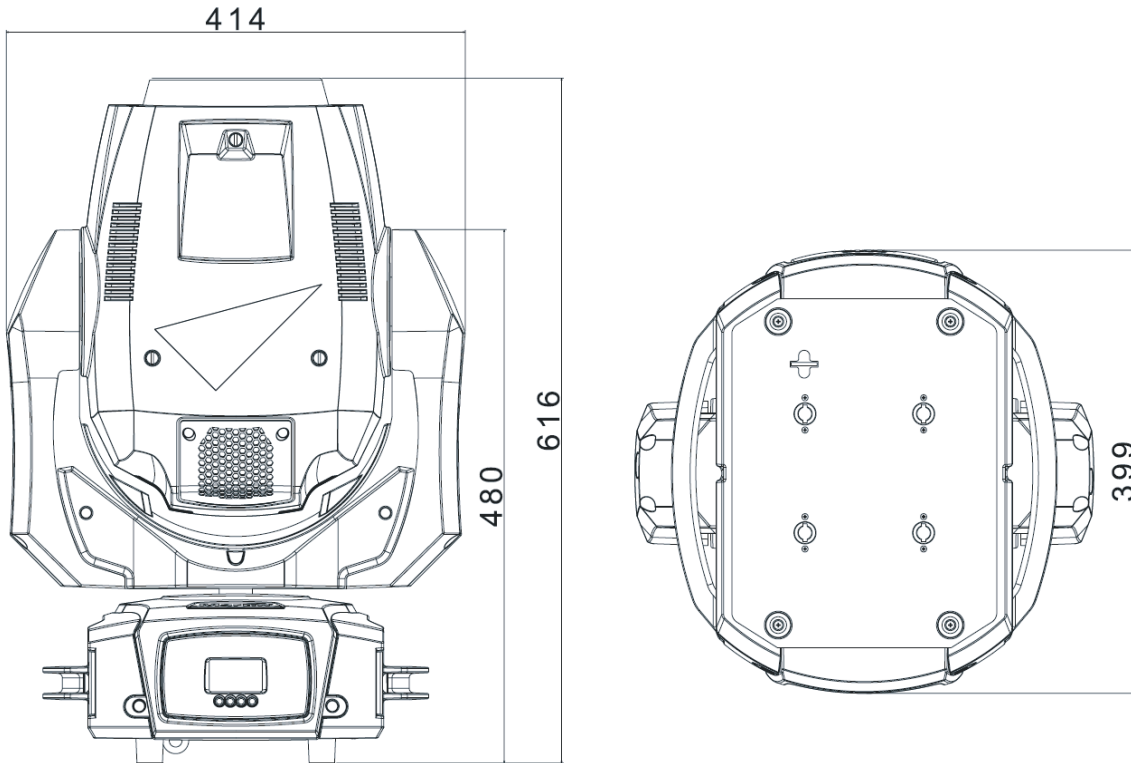

Dynamic Effects

Color mixing	CMYC, independently variable 0 – 100%
Color wheel	16 dichroic filters, stepped,continuous rotation, random color
Rotating gobo wheel	9 interchangeable rotating gobos, indexing,shake, continuous scrolling and rotation
Fixed gobo wheel.....	3 irises, pinspot, 12 fixed gobos, frost and gobo animationeffects with continuous scrolling, random gobo
Prisms	3-facet 15° and 8-facet 15° rotating prismswith dynamic “prism lineator” zoom effect
Frost.....	Frost filter for wash effect
Mechanical dimmer/shutter	0 - 100% dimming, strobe effect 2 - 10 Hz, pulseeffects, instant open and blackout
Focus	2 m (6.6 ft.) to infinity
Zoom	2°-44° continuous (no Beam or Spot modes)
Pan.....	540°
Tilt	260°

Control and Programming

Control platform.....	DMX and RDM
DMX channels.....	23
Setting and addressing	Onboard control panel or via DMX
16-bit control	Focus, pan and tilt
Onboard display panel.....	Backlit LCD with auto-flip

DMX compliance USITT DMX512-A
 RDM compliance ANSI/ESTA E1.20
 Receiver Isolated RS-485
 Firmware update Windows PC and USB-DMX hardware interface

Lamp

Approved lamp Osram SIRIUS HRI 440 W
 Type 440 W short-arc discharge
 Color temperature 7000 K
 CRI (Color rendering index) 80
 Average lifetime (manufacturer's figure, to min. 70% output) 1500 hours

Construction

Color Black
 Housing Alloy, steel, UV-resistant fiber-reinforced composite
 Protection rating IP 20

Installation

Mounting points Four quarter-turn locking points
 Minimum distance to illuminated surfaces 15 m (49.3 ft.)
 Minimum distance to combustible materials 0.2 m (0.7 ft.)
 Orientation Any

Connections

AC power input Neutrik PowerCon TRUE1
 DMX and RDM data in/out 5-pin locking XLR

Electrical

AC power 100-240 V nominal, 50/60 Hz
 Fuse 250 V, T 8 A (slow blow)
 Power supply unit Auto-ranging electronic switch-mode

Typical Power and Current

110 V, 60 Hz 5.5 A, 600 W, PF > 0.9 typical
 230 V, 50 Hz 2.7 A, 600 W, PF > 0.9 typical

Measurements made at nominal voltage. Figures are typical, not maximum. Allow for a deviation of +/- 10%.

Thermal

Cooling Forced air
 Maximum ambient temperature (Ta max) 40° C (104° F)
 Maximum surface temperature, steady state, at Ta max 90° C (194° F)
 Total heat dissipation (calculated, +/- 10% at 230 V, 50 Hz) 2050 BTU/hr.

Approvals



EU safety EN 60598-2-17 (EN 60598-1), EN 62471, EN 62493
 EU EMC EN 55015; EN 55032; EN 55103-1,-2; EN61000-3-2,-3;
 EN 61000-4-2,-4; EN 61547
 US safety UL 1573
 US EMC FCC Part 15 Class A
 Canadian safety CSA C22.2 No. 166
 Canadian EMC ICES-003 Class A
 Australia/New Zealand (pending) RCM

Included Items

Two mounting brackets with quarter-turn fasteners

Accessories

Flightcase for 2 x MAC Axiom Hybrid P/N 91515037

Power cables

Power Input Cable, H07RN-F, 2.5 mm², 14 AWG,
bare ends to Neutrik TRUE1 NAC3FX-W (female), 1.5 m (4.9 ft.) P/N 91611797

Power Input Cable, H07RN-F, 2.5 mm², 14 AWG,
bare ends to Neutrik TRUE1 NAC3FX-W (female), 5 m (16.4 ft.) P/N 91611786

Power Input Cable, SJOOW, 12 AWG,
bare ends to TRUE1 NAC3FX-W (female), 1.5 m (4.9 ft.)..... P/N 91610173

Power Input Cable, SJOOW, 12 AWG,
bare ends to TRUE1 NAC3FX-W (female), 5 m (16.4 ft.)..... P/N 91610174

Power connectors

Cable Connector, Neutrik PowerCON TRUE1 NAC3FX-W (female) P/N 91611789

Installation hardware

Half-coupler clamp P/N 91602005

G-clamp (suspension with yoke vertically downwards only)..... P/N 91602003

Quick-trigger clamp (suspension with yoke vertically downwards only)..... P/N 91602007

Related Items

Martin® M-DMX USB-to-DMX Interface Box P/N 90737060

Ordering Information

MAC Axiom™ Hybrid in Cardboard Box..... P/N 90490000

Specifications are subject to change without notice. For latest product specifications, see www.martin.com

	<p>Disposing of this product</p>	<p>Martin® products are supplied in compliance with Directive 2012/19/EC of the European Parliament and of the Council of the European Union on WEEE (Waste Electrical and Electronic Equipment), where applicable. Help preserve the environment! Ensure that this product is recycled at the end of its life. Your supplier can give details of local arrangements for the disposal of Martin® products</p>
---	---	---

Photobiological Safety Warning

<p>Risk Group 2</p>
<p>CAUTION. Possibly hazardous optical radiation emitted from this product. Do not stare at operating lamp. May be harmful to the eye</p>
<p><i>Product tested against EN62471</i></p>

The warning shown above is printed on this product. If it becomes difficult or impossible to read, it must be replaced using the above illustration to reproduce a label in black with a yellow background.



www.martin.com · Olof Palmes Allé 18 · 8200 Aarhus N · Denmark
Tel: +45 8740 0000 · Fax +45 8740 0010